

207 SERIES

Vertical Hold Down Clamps | Product Overview

Features:

- Largest selection of arm and mounting options
- Low profile T-Handle version available
- Available in stainless steel
- BLK models feature a black, non-reflective finish
- 5 handle colors - see page MC-PRO-7 for details

Applications:

- Checking fixtures
- Assembly & test
- Light machining
- Woodworking

Also Available:

See page MC-ACC-1 for accessories

807-U Pneumatic toggle clamp
(See page MC-PTC-6)

807-S Pneumatic toggle clamp
(See page MC-PTC-6)

Accepts M8 or 5/16 spindle accessories

207-U
Flanged Base
U-Bar



-USS Stainless
Steel Model



207-UL
Flanged Base
Long U-Bar



207-S
Flanged Base
Solid Bar



207-L
Flanged Base
Long Solid Bar



207-TU
Flanged Base
T-Handle
U-Bar



207-TUL
Flanged Base
T-Handle
Long U-Bar



207-UR
Flanged Base
U-Bar
DESTACO®
Toggle Lock
Plus



207-LR
Flanged Base
Long Solid Bar
DESTACO®
Toggle Lock
Plus



207-UB
Straight Base
U-Bar



207-ULB
Straight Base
Long U-Bar



207-SB
Straight Base
Solid Bar



207-LB
Straight Base
Long Solid
Bar



207-LBR ⓘ
Straight Base
Long Solid Bar
DESTACO®
Toggle Lock
Plus



207-UF ⓘ
U-Bar
Dual Mount



207-SF ⓘ
Solid Bar
Dual Mount



207-U-L ⓘ
Flange Base
Open Bar



207-U-L-BLK
Blackout Series
Flanged Base
Open U-Bar



207-UB-L ⓘ
Straight Base
Open Bar



207-UB-L-BLK
Blackout Series
Straight Base
Open U-Bar



207305
Flanged Grip. Provides added safety and protection. Fits all 207 Series (except T-Handle) clamps. Order separately.



Color Handles

Available on models in this series that use standard red handles.* Add **-Y, -G, -B, -K** to end of model number.

*Excludes Blackout Series, Toggle Lock Plus levers or dipped handles.



ⓘ This item is available upon request

| Model | Max. Holding Capacity | Clamp Bar Opening (+10°) | Handle Opening (+10°) | Weight | Accessories (Supplied) | | | | | | |
|----------------|-----------------------|--------------------------|-----------------------|--------------------|------------------------|-----------------------|-----------------|-----------------------|--------|--------------------|------------|
| | | | | | Bolt Retainer | Spindle Assembly | Flanged Washers | | | | |
| 207-U | [375 lbf] 1670 N | 99° | 57° | 0,30 kg [0.67 lbs] | --- | 225208-M | 507107 | | | | |
| 207-UR | | | | 0,45 kg [1.00 lbs] | | | | | | | |
| 207-UL | | | | 0,30 kg [0.67 lbs] | | | | | | | |
| 207-USS | 2000 N [450 lbf] | | | --- | 207943-M | 507907 | | | | | |
| 207-S | [500 lbf] 2220 N | | | 99° | 57° | 0,31 kg [0.69 lbs] | 207105 | --- | --- | | |
| 207-L | | | | | | 0,34 kg [0.74 lbs] | | | | | |
| 207-LR | | | | | | 0,45 kg [1.00 lbs] | | | | | |
| 207-UB | [375 lbf] 1670 N | | | 99° | 57° | [0.72 lbs] 0,33 kg | --- | 225208-M | 507107 | | |
| 207-ULB | | | | | | | | | | | |
| 207-SB | [500 lbf] 2220 N | | | | | 99° | 57° | 0,31 kg [0.69 lbs] | 207105 | --- | --- |
| 207-LB | | | | | | | | 0,34 kg [0.75 lbs] | | | |
| 207-LBR ⓘ | | | | | | | | 0,45 kg [1.00 lbs] | | | |
| 207-TU | [375 lbf] 1670 N | | | | | 99° | 57° | [0.72 lbs] 0,33 kg | --- | --- | 507107 |
| 207-TUL | | | | | | | | | | | |
| 207-UF ⓘ | 1670 N [375 lbf] | | | | | | | 96° | 56° | 0,43 kg [0.94 lbs] | --- |
| 207-SF ⓘ | 2220 N [500 lbf] | 90° | | | | | | 0,38 kg [0.84 lbs] | 207105 | --- | --- |
| 207-U-L ⓘ | [375 lbf] 1670 N | 99° | 57° | | | | | [0.84 lbs] 0,38 kg | --- | --- | 507107 |
| 207-U-L-BLK ⓘ | | | | | | | | | | | 507107-BLK |
| 207-UB-L ⓘ | | | | | | | | | | | 507107 |
| 207-UB-L-BLK ⓘ | | | | | | | | | | | 507107-BLK |

ⓘ This item is available upon request

Holding Capacities

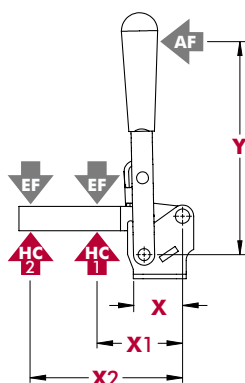

| Model | X | X1 | X2 | Y | ±HC1 | ±HC2 | ±EF(X1):AF | ±EF(X2):AF |
|----------------|----------------|----------------|----------------|-----------------|---------------------|----------------------|------------|------------|
| U/UB/UR | | [2.00] 50,8 | [3.75] 95,3 | | [375 lbf] 1670 N | [225 lbf] 1000 N | 12:1 | 6:1 |
| UL/ULB | | [3.88] 98,5 | [5.00] 127 | | | [150 lbf] 670 N | 7:1 | 4:1 |
| USS | | [2.00] 50,8 | [3.75] 95,3 | [4.90] 124,5 | [450 lbf] 2000 N | [240 lbf] 1070 N | | 5:1 |
| S/SB | | [2.88] 73,0 | | | [500 lbf] 2220 N | [350 lbf] 1560 N | 10:1 | 7:1 |
| L/LR LB/LBR | [1.28] 32,6 | [2.88] 73,0 | [5.00] 127 | | | | | 5:1 |
| TU | | [2.00] 50,8 | [3.75] 95,3 | [3.66] 9 | [375 lbf] 1670 N | [225 lbf] 1000 N | 6:1 | 4:1 |
| TUL | | [3.88] 98,5 | [5.00] 127 | | | [150 lbf] 670 N | 4:1 | 3:1 |
| U-L | | [2.00] 50,8 | [3.75] 95,3 | [4.90] 124,5 | [375 lbf] 1670 N | [2225 lbf] 1000 N | 12:1 | 6:1 |
| UB-L | | | | | | | | |

Dimensions shown "mm [inch]" ± HC = Holding Capacity, EF = Exerting Force, AF = Applied Force

207 SERIES

Vertical Hold Down Clamps | Dimensions | -U/-UL/-S/-L/-TU/-TUL/-UR/-LR/-UB/-ULB/-SB/-LB/-LBR

207-U Flanged Base U-Bar

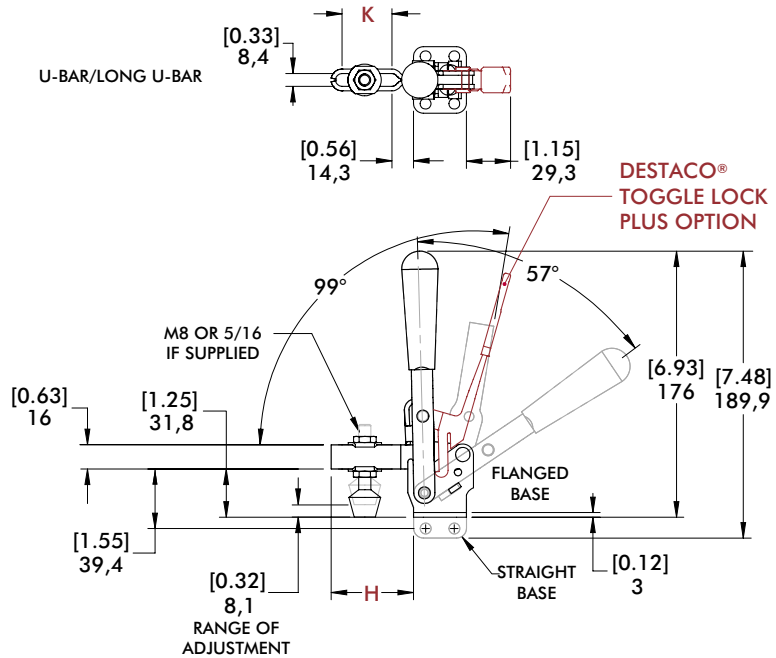
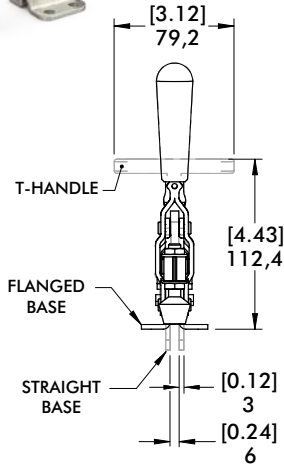

207-SB Straight Base Solid Bar

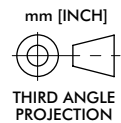
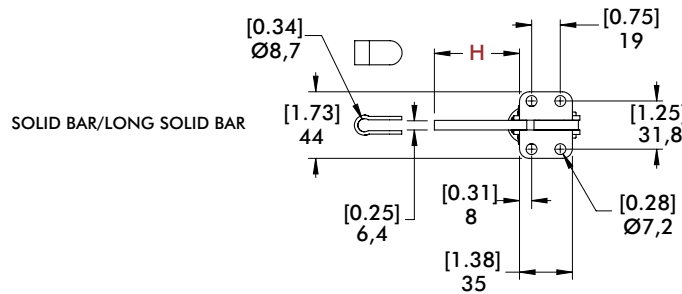

| Bar Style | Clamp Models | H | K |
|-----------|-------------------------------|-------------|-------------|
| | 207-U/207-UR/207-TU/207-UB | [2.14] 54,4 | [1.30] 33 |
| | 207-UL/207-ULB/207-TUL | [3.84] 97,6 | [2.94] 74,6 |
| | 207-S/207-SB | [2.21] 56,2 | --- |
| | 207-L/207-LR/207-LB/207-LBR ⓘ | [3.48] 88,4 | --- |

ⓘ This item is available upon request

207 SERIES

Vertical Hold Down Clamps | Dimensions | Dual Mount

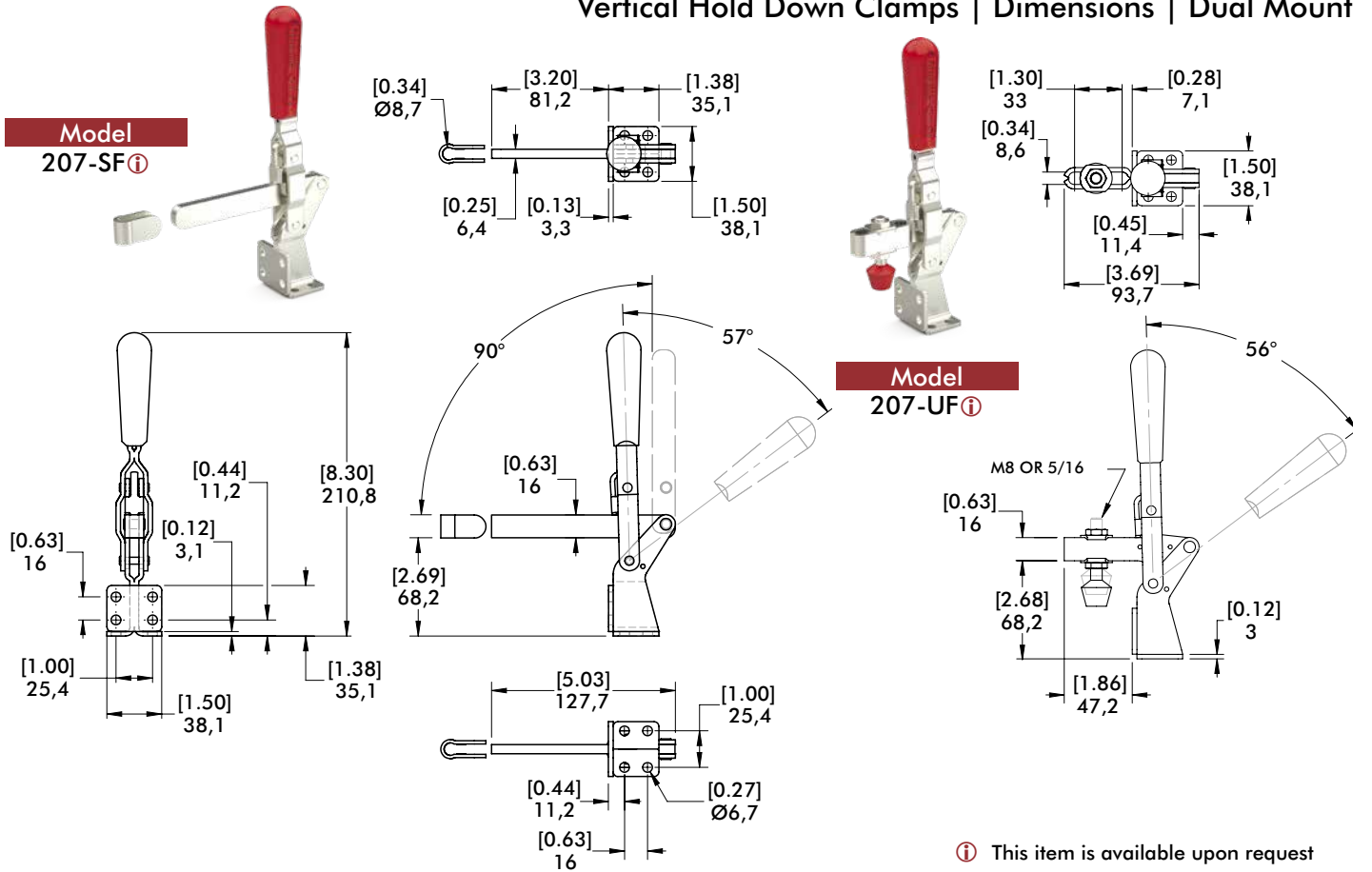

Open Bar Option

See page MC-ACC-7 for Complete offering of Open bar accessories

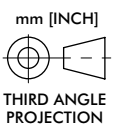
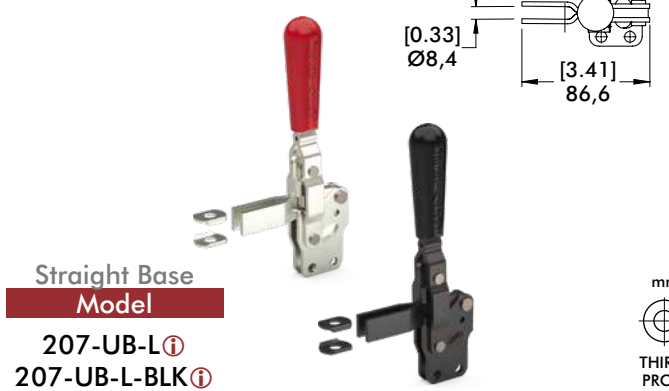
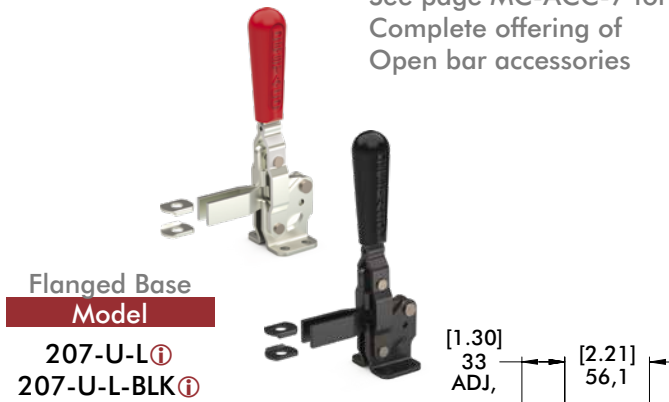

Stainless Steel

